

Mezzano

Wallmount hood



Learn
more

MEASUREMENTS

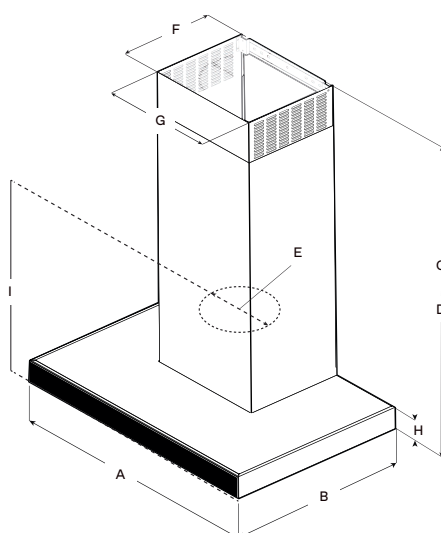

	EMZ630S3	EMZ636S3
A	30" (76.2 cm)	36" (91.4 cm)
B	19 1/8" (50cm)	
C*	Min: 33 7/8" (86 cm) Max: 54 3/4" (139 cm)	
D**	Min: 29 1/8" (77cm) Max: 50 5/8" (129 cm)	
E	6" (15.24 cm)	
F	10 3/4" (27 cm)	
G	13" (33 cm)	
H	2 1/8" (6 cm)	2 5/8" (4 cm)
I	16 7/8" (40.8 cm)	

*Ductless (recirculating)







**Ducted version

DESCRIPTION

With a minimalist design and strong stainless steel construction, Mezzano complements avant-garde appliances where clear, architectural lines take precedence. Mezzano features a powerful 600 CFM blower, dimmable LED lighting, stainless steel microhole filters, and high-tech multi-function touch controls for convenience and safety. Designed for standard ducted installation, Mezzano can also be installed using the optional Recirculating Kit.



FEATURES

-  Hush system
-  Dim light
-  Top performance
-  Touch controls
-  CFM reduction system
-  Led light



GENERAL PROPERTIES

Width	30"	36"
Model	EMZ630S3	EMZ636S3
Dimensions	30"W x 19 1/16"D x min:33 7/8" max:54 3/4"H	36"W x 19 1/16"D x min:33 7/8" max:54 3/4"H
Blower Type (Internal) ¹	600 CFM (3-speed+ boost)	
Noise (Min-max sones) ¹	1.7-6.8 Sones	
Electrical	120V-60Hz,455W	
Illumination	2 premium dimmable LED, 2.5W, 4000K	
Finish	Stainless Steel with black tempered glass	
Controls	Multi-function Electronic with black glass touch display	
Grease filters	Stainless steel microhole filter	
Installation type	Ducted or recirculating with kit (sold separately)	
Telescopic chimney	Can reach ceiling heights of min 7'6", max 10'2" (ducted out) & min 7'10", max 10'6" (recirculating)	
Duct transition	Round 6" (top only)	

KITS

Recirculating Kit	KIT0102875 (Contains 6" deflector & 2 round carbon filters)
Chimney Extension	KIT02785 (Can reach 8'6" - 12'2" (ducted), 8'10"-12'6" (recirculating))

WARRANTY:² Two (2) Years Parts & In-Home Labor. Earn an additional One (1) Year of Parts & In-Home Labor by registering on elica.com



The product images shown are for illustration purposes only and may not be an exact representation of the product.
¹ CFM and Noise data indicate the performance of the hood blower tested according to international standards. For AHAM Certified Ratings, established in accordance with California Title 24 Standardized test procedure, please refer to AHAM Certified Product Directory. Electric Ratings are declared according to UL.

² For valid warranty extension, register within 3 months from purchase. For USA & Canada Users Only.